

Planetary Mixers

Planetary Mixer, 5 lt - Electronic with Hub, White

ITEM # _____

MODEL # _____

NAME # _____

SIS # _____

AIA # _____

600190 (EMX5BWH)

Emix Planetary Mixer white, 5 liters, bowl detection device, electronic variable speed with K type accessory hub. Equipped with stainless steel semi spiral hook, paddle and whisk and highly resistant splashguard - BPA free

Short Form Specification

Item No.

Suitable for all kneading, blending and whipping operations. Metal body and large base for complete stability. 5,5 litre capacity 18/10 (AISI 304) stainless steel bowl with 2 handles. Universal motor with electronic speed variation from 40 to 240 rpm (planetary movement), driving the whisk up to 500 rpm. Removable and dismantled solid safety screen - made of a bisphenol-A free (BPA) copolyester - activates the raising and lowering of the bowl. Equipped with accessory drive hub type k (accessories are not included). Bowl detection device allows the mixer to switch on only when the bowl and the safety screen are properly installed and positioned together. Supplied with 3 stainless steel tools: semi-spiral hook, paddle and whisk.

Main Features

- Small, compact planetary mixer designed to whisk and mix, providing also good kneading results.
- Maximum capacity (flour, with 60% of hydration) 0,75 kg.
- Tools shape and size perfectly adapt to the bowl for uniform mixing of even small quantities.
- Electronic speed variator.
- Removable safety screen activates the raising and lowering of the bowl.
- Delivered with:
 - Paddle, Semi-spiral Hook, Wire Whisk and Mixing Bowl for 5,5 lt
 - K type accessory drive hub (accessories are not included)
- Safety device will automatically stop the machine when the bowl is lowered.
- Bowl detection device allows the mixer to switch on only when the bowl and the solid safety screen are properly installed and positioned together.

Construction

- Compact design.
- Semi-spiral hook, paddle and wire whisk in stainless steel.
- 304 AISI stainless steel bowl with 2 handles - 5,5 lt capacity.
- Universal powerful motor with high start-up torque and overload protection.
- Variable speed from 40 to 240 rpm (planetary movement), to adjust to the selected tool and mixture hardness.
- Variable speed rotation of the tools from 84 rpm to 500 rpm.
- Power: 500 Watts.
- Transparent solid safety screen made of Eastman Tritan™ copolyester BPA free, impact resistant and stays clear and durable after several dishwashing cycle. Eastman&Tritan are trademarks for Eastman Chemical Company.
- Water protected planetary system (IP55 electrical controls, IP34 overall machine).

Included Accessories

- 1 of Stainless steel bowl with handles 5 lt PNC 653754
- 1 of Stainless steel semi-spiral hook 5 lt PNC 653755
- 1 of Stainless steel paddle 5 lt PNC 653756
- 1 of Stainless steel whisk 5 lt PNC 653757

Optional Accessories

- 60 mm meatmincer for attachment type K (12 mm square hub) and 1 disc PNC 653043
- 3 discs (3-4,5-8 mm) for meatmincer PNC 653044
- Pasta kit accessory (lasagne 142,5 mm) PNC 653296

APPROVAL: _____



Electrolux
PROFESSIONAL

Planetary Mixers Planetary Mixer, 5 lt - Electronic with Hub, White

- Pasta kit accessory (spaghetti 2 mm) PNC 653298
- Pasta kit (lasagne, tagliatelle, tagliolini) PNC 653300
- Stainless steel bowl with handles 5 lt PNC 653754
- Stainless steel semi-spiral hook 5 lt PNC 653755
- Stainless steel paddle 5 lt PNC 653756
- Stainless steel whisk 5 lt PNC 653757



Planetary Mixers
Planetary Mixer, 5 lt - Electronic with Hub, White

The company reserves the right to make modifications to the products without prior notice. All information correct at time of printing.

2024.12.21

Front

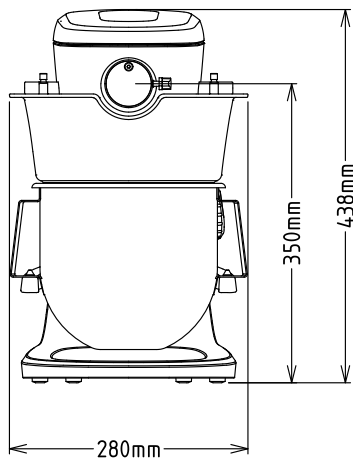

Side

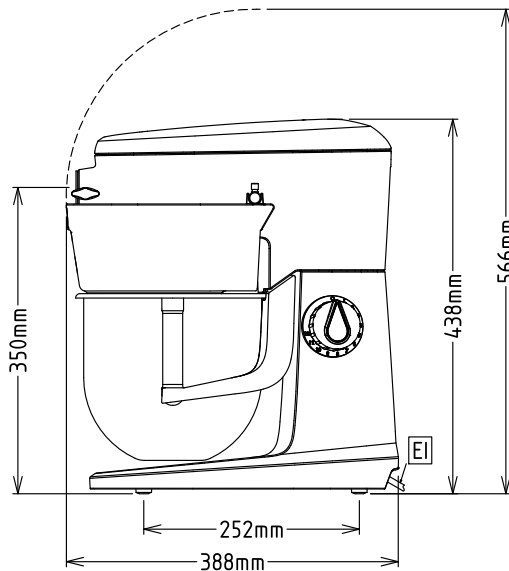

EI = Electrical inlet (power)

Top

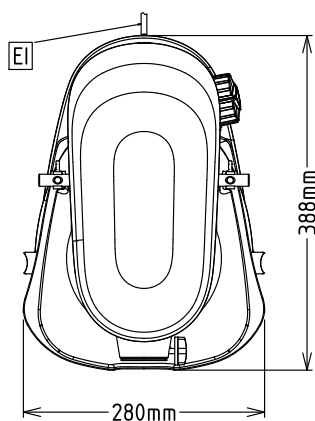
Electric
Supply voltage:

600190 (EMX5BWH) 200-240 V/1N ph/50/60 Hz

Total Watts:

0.5 kW

Capacity:
Performance (up to): 0.75 kg/Cycle

Capacity: 5.5 litres

Key Information:
External dimensions, Width: 280 mm

External dimensions, Depth: 388 mm

External dimensions, Height: 438 mm

Shipping weight: 15 kg

Net weight (kg): ISO 9001; ISO 14001

0.75 kg with Semi spiral hook

Cold water paste:

hook

Egg whites:

12 with Whisk